

OVERALL HEIGHT = 118.5"  
OVERALL WIDTH WITH RUB  
RAILS & FENDERETTES = 98"

POWER ARC LIGHT BAR- LED-XTT76LB-RWRRWR-FF6

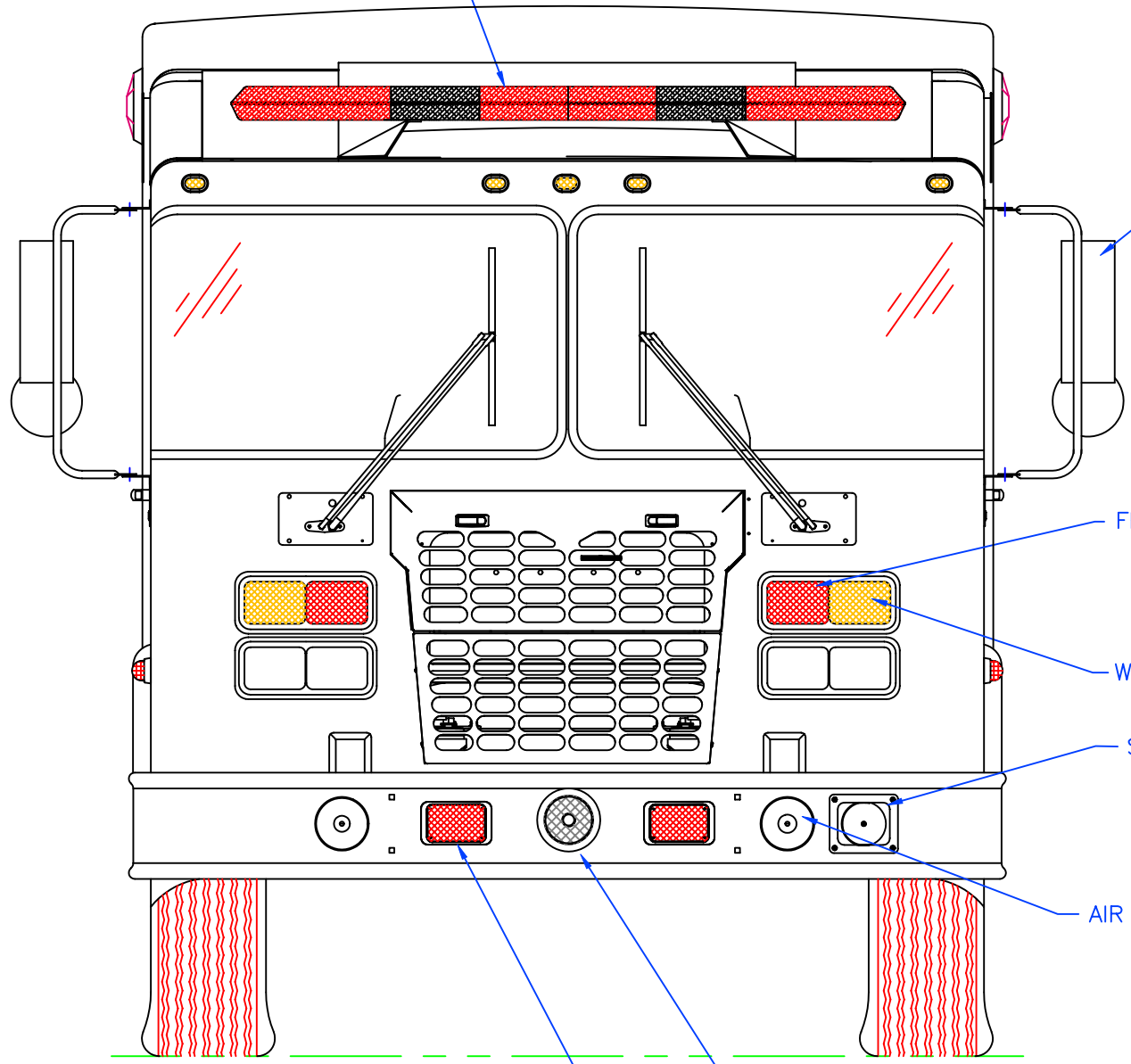

MOTO-MIRROR PLUS

FEDERAL 4x6 RED QUADRAFLARE

WHELEN 600 LED TURN SIGNAL

SIREN SPEAKERS

AIR HORNS

SCREAMING EAGLE SIREN

FEDERAL 4x6 RED QUADRAFLARE



2010 FRONT EXTERIOR VIEW  
SUPER CHIEF METRO

1:18

DATE:	4 JAN 10	
DWG.	TKD	REV.
		NR

DRAWING NO.  
MSSC-1

OVERALL HEIGHT = 118.5"  
OVERALL WIDTH WITH RUB  
RAILS & FENDERETTES = 98"

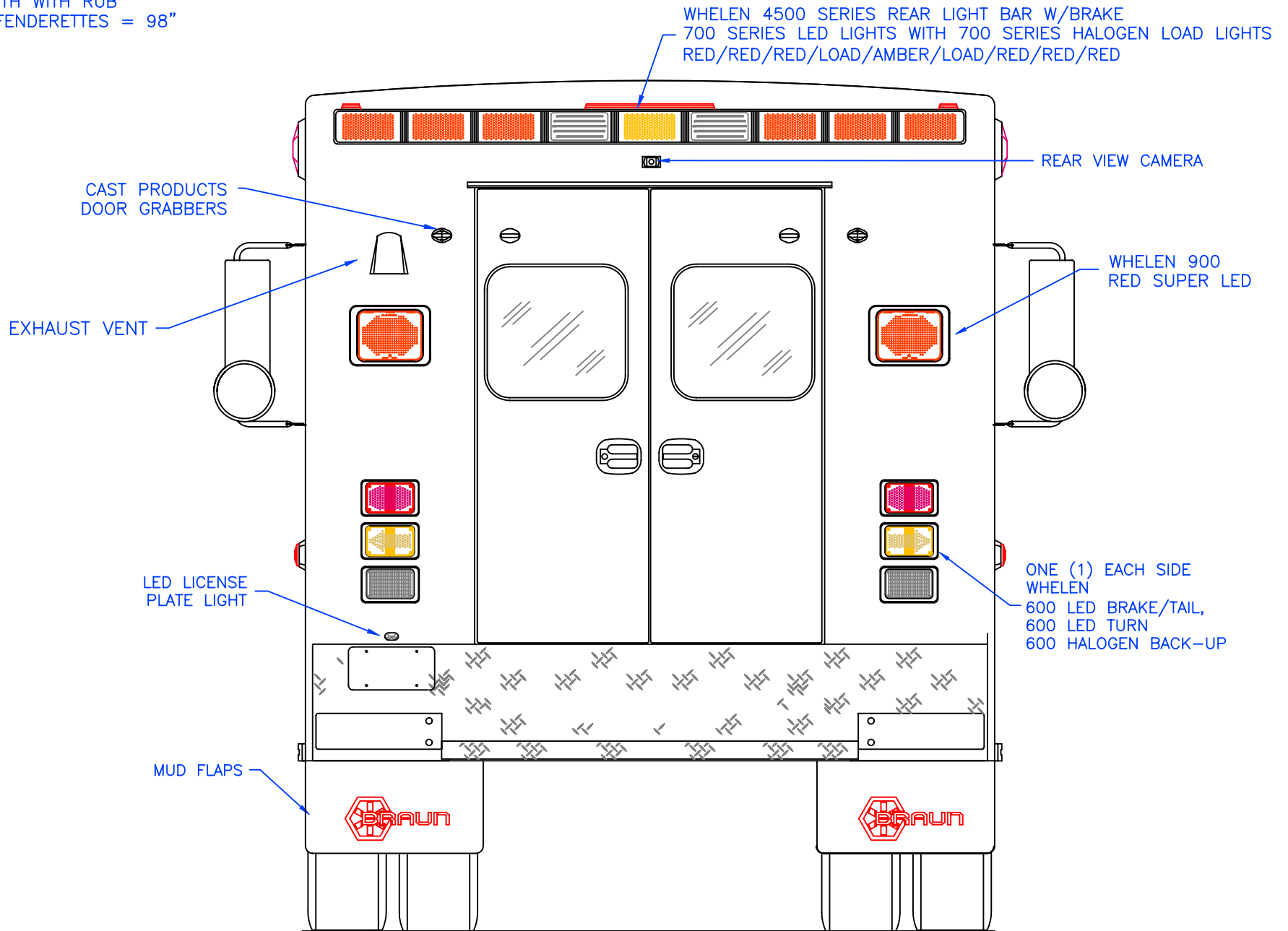

2010 REAR EXTERIOR VIEW  
SUPER CHIEF METRO

1:18

DATE:  
4 JAN 09  
DWG. REV.  
TKD NR

DRAWING NO.  
MSSC-2

OVERALL HEIGHT = 118.5"  
 OVERALL LENGTH = 317" APPROX.  
 MODULE LENGTH = 191"

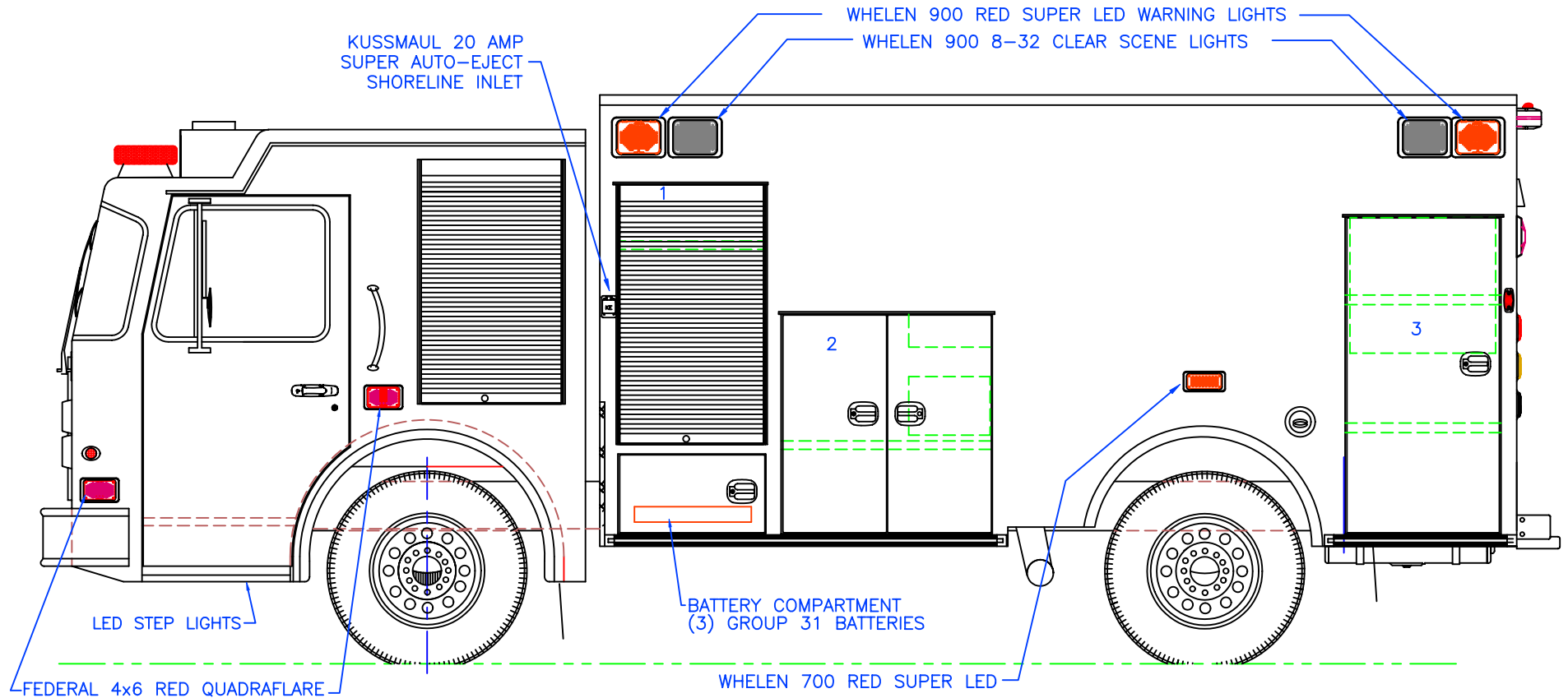

COMPARTMENT  
 CAB ROLL-UP COMPARTMENT  
 CLEAR OPENING: 51.00h x 30.00w  
 TRANSVERSE COMPARTMENT

O.S.S #1  
 CLEAR OPENING: 53.75h x 30.00w  
 INSIDE DIM'S.: 58.125h x 30.00w x 21.75d  
 TRANSVERSE BACKBOARD STORAGE  
 ONE (1) ADJUSTABLE SHELF

O.S.S #2  
 CLEAR OPENING: 40.25h x 38.25w  
 INSIDE DIM'S.: 43.50h x 43.75w x 21.75d  
 ONE (1) ADJUSTABLE SHELF

O.S.S #3  
 CLEAR OPENING: 63.50h x 29.50w  
 INSIDE DIM'S.: 65.25h x 32.75w x 21.75d  
 INSIDE/OUTSIDE ACCESS  
 TWO (2) ADJUSTABLE SHELVES

DIMENSIONS ARE NOMINAL



2010 STREETSIDE EXTERIOR VIEW  
 SUPER CHIEF METRO

DATE: 4 JAN 10		DRAWING NO. MSSC-3	
DWG. TKD	REV NR	1:30	

OVERALL HEIGHT = 118.5"  
 OVERALL LENGTH = 317" APPROX.  
 MODULE LENGTH = 191"

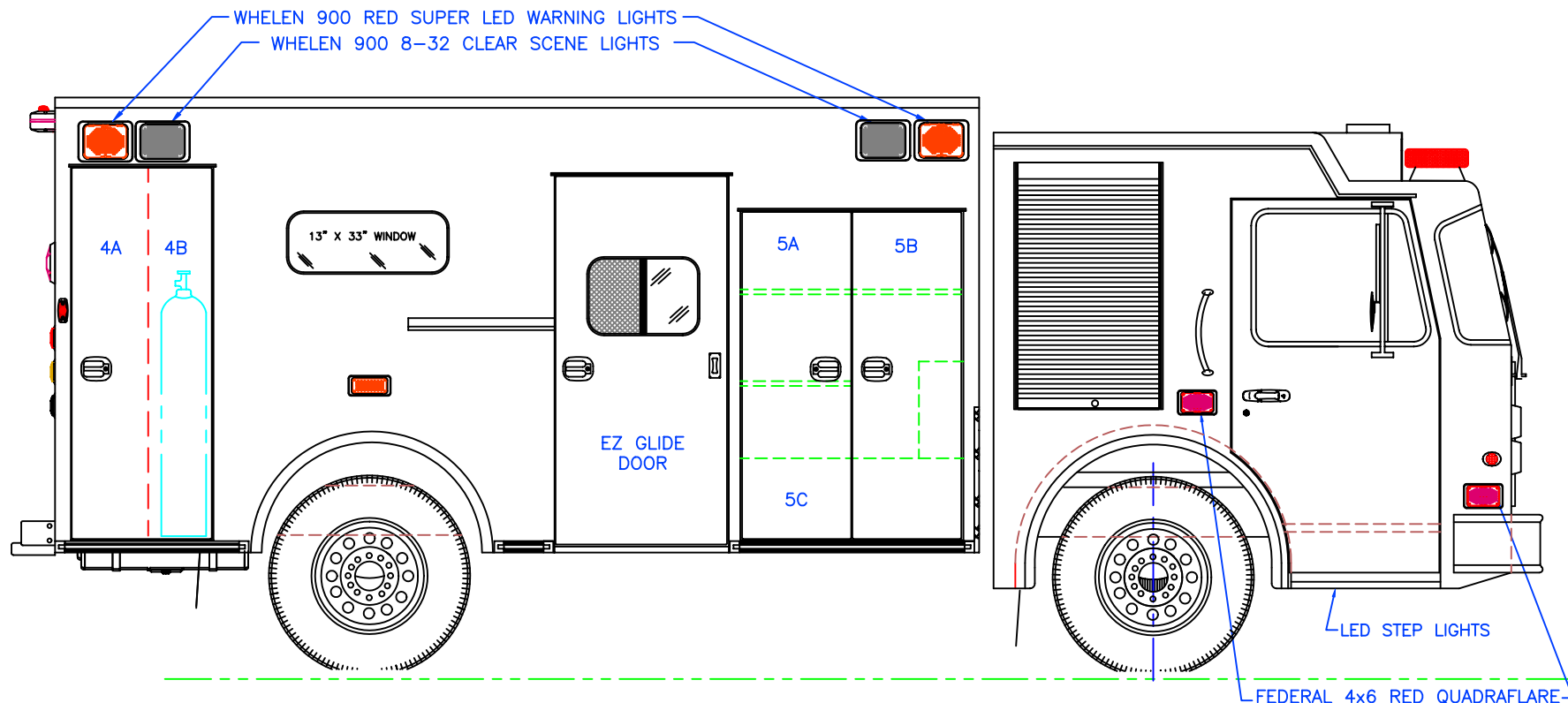

COMPARTMENT

O.S.S #4

CLEAR OPENING: 75.50h x 25.25w  
 INSIDE DIM'S. 4A: 76.50h x 16.00w x 21.75d  
 BACKBOARD/SCOOP STORAGE

INSIDE DIM'S. 4B: 76.50h x 13.50w x 13.00d  
 OXYGEN CYLINDER STORAGE

O.S.S #5

CLEAR OPENING: 66.50h x 41.13w  
 INSIDE DIM'S. 5A: 49.50h x 24.50w x 28.50d  
 INSIDE/OUTSIDE STORAGE WITH TWO (2) ADJUSTABLE SHELVES

INSIDE DIM'S. 5B: 49.50h x 24.50w x 28.50d  
 ADJUSTABLE SHELF, TRANSVERSE BACKBOARD STORAGE

INSIDE DIM'S. 5C 16.25h x 46.00w x 16.50d

CAB ROLL-UP COMPARTMENT  
 CLEAR OPENING: 51.00h x 30.00w  
 TRANSVERSE COMPARTMENT

DIMENSIONS ARE NOMINAL



2010 CURBSIDE EXTERIOR VIEW  
 SUPER CHIEF METRO

1:30

DATE: 4 JAN 10	
DWG. TKD	REV. NR

DRAWING NO.  
MSSC-4

COMPARTMENTS: #1/#2, #3, AND #4 HAVE RESTOCKING FRAMES

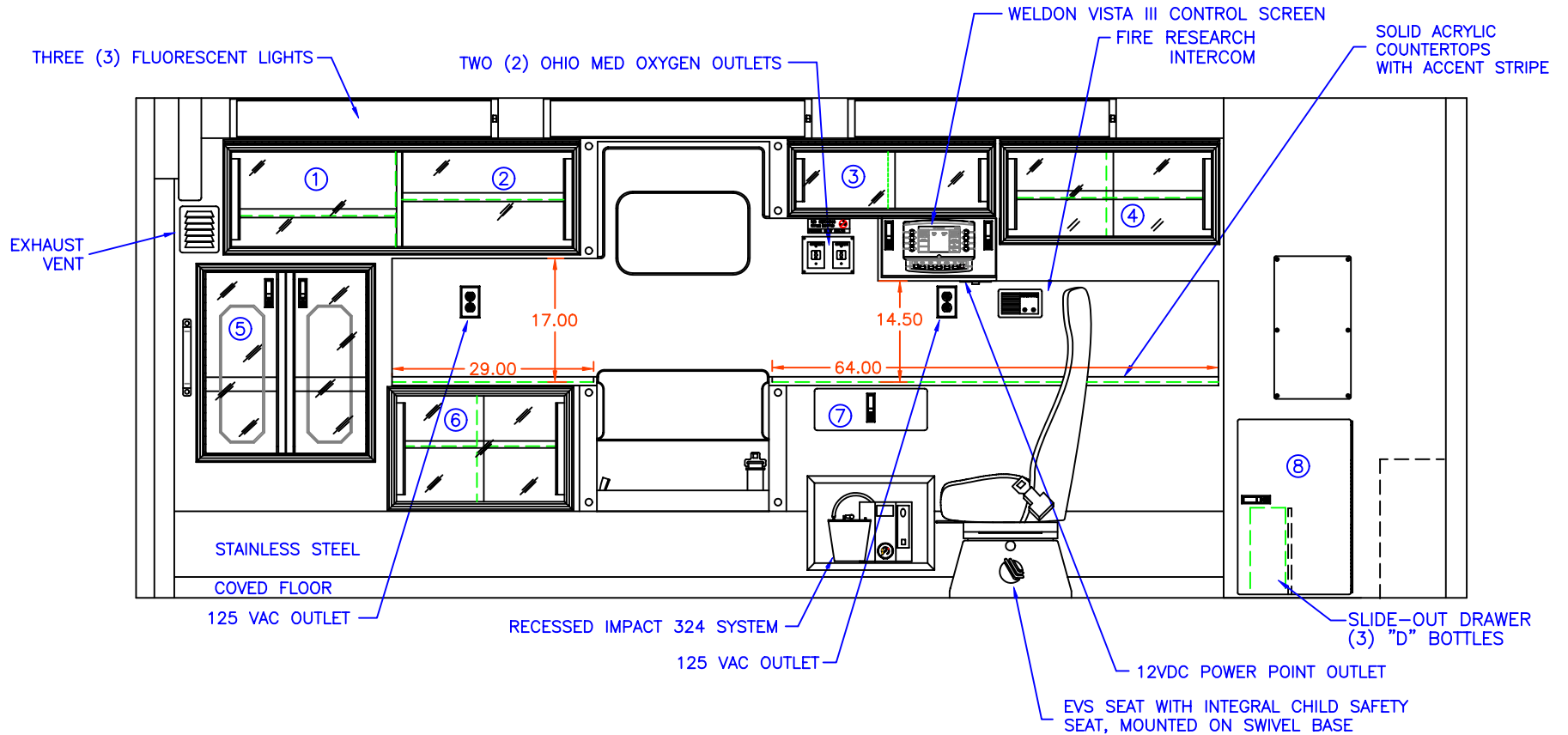

COMPARTMENT

- #1,#2 DOOR OPENING: 13.50h x 49.00w  
INSIDE DIMS: 16.00h x 51.00w x 19.50d  
PERMANENT DIVIDER; ONE (1) ADJUSTABLE SHELF EA. SIDE
- #3 DOOR OPENING: 7.75h x 27.50w  
INSIDE DIMS: 10.25h x 29.50w x 19.50d
- #4 DOOR OPENING: 12.00h x 29.25w  
INSIDE DIMS: 19.00h x 31.25w x 19.50d  
ONE (1) ADJUSTABLE SHELF

- #5 DOOR OPENING: 26.25h x 23.50w  
INSIDE DIMS: O.S.S. #3  
RECESSED .375" ACRYLIC DOORS WITH FULL LENGTH HANDLES  
TWO (2) LOCKING LEVER LATCHES
- #6 DOOR OPENING: 15.00h x 24.00w  
INSIDE DIMS: 16.75h x 28.25w x 18.50d  
ONE (1) ADJUSTABLE SHELF
- #7 PULL-OUT DRAWER WITH HINGED ACRYLIC WRITING SURFACE  
INSIDE DIMS: 5.00h x 14.50w x 13.25d  
LOCKING LEVER LATCH
- #8 DOOR OPENING: 24.50h x 15.75w  
INSIDE DIMS: 25.00h x 18.75w x 14.50d  
ALUMINUM DOOR, LOCKING LEVER LATCH

DIMENSIONS ARE NOMINAL



2010 STREETSIDE INTERIOR VIEW  
SUPER CHIEF METRO

1:22

DATE:	9 JAN 10
DWG.:	TKD
REV.:	NR

DRAWING NO.	MSSC-5
-------------	--------

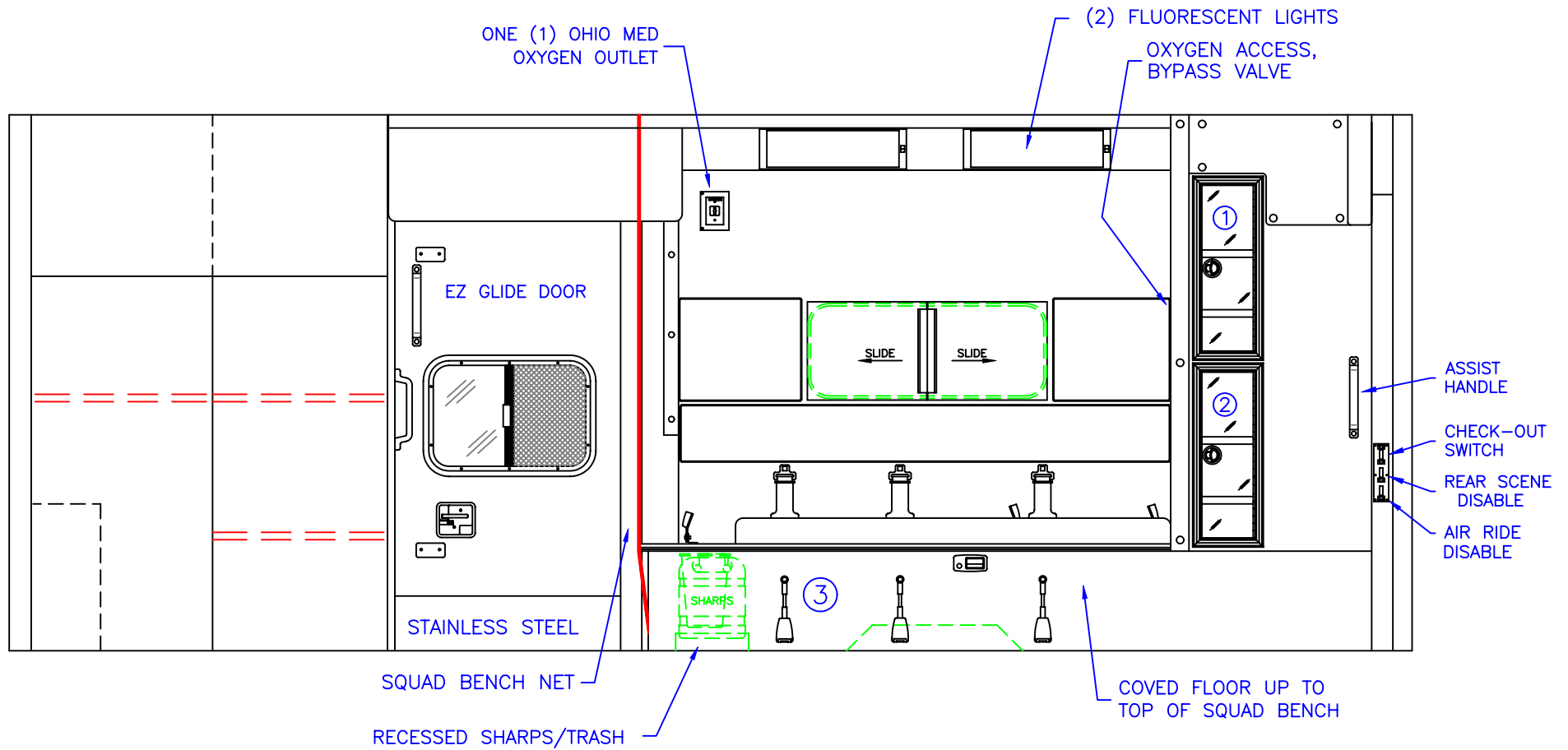

COMPARTMENT

- #1-#2 DOOR OPENINGS: 22.75h x 7.25w
- INSIDE DIMS: 26.00h x 13.25w x 7.50d
- RECESSED .375" ACRYLIC DOORS
- ONE (1) FLUSH PULL LATCH PER DOOR
- TWO (2) ADJUSTABLE SHELVES PER CABINET
- #3 INSIDE DIM'S: 14.25h x 71.75w x 21.00d

DIMENSIONS ARE NOMINAL



2010 CURBSIDE INTERIOR VIEW  
SUPER CHIEF METRO

DATE:  
9 JAN 10  
DWG. TKD  
REV. NR

DRAWING NO.  
MSSC-6

1:20

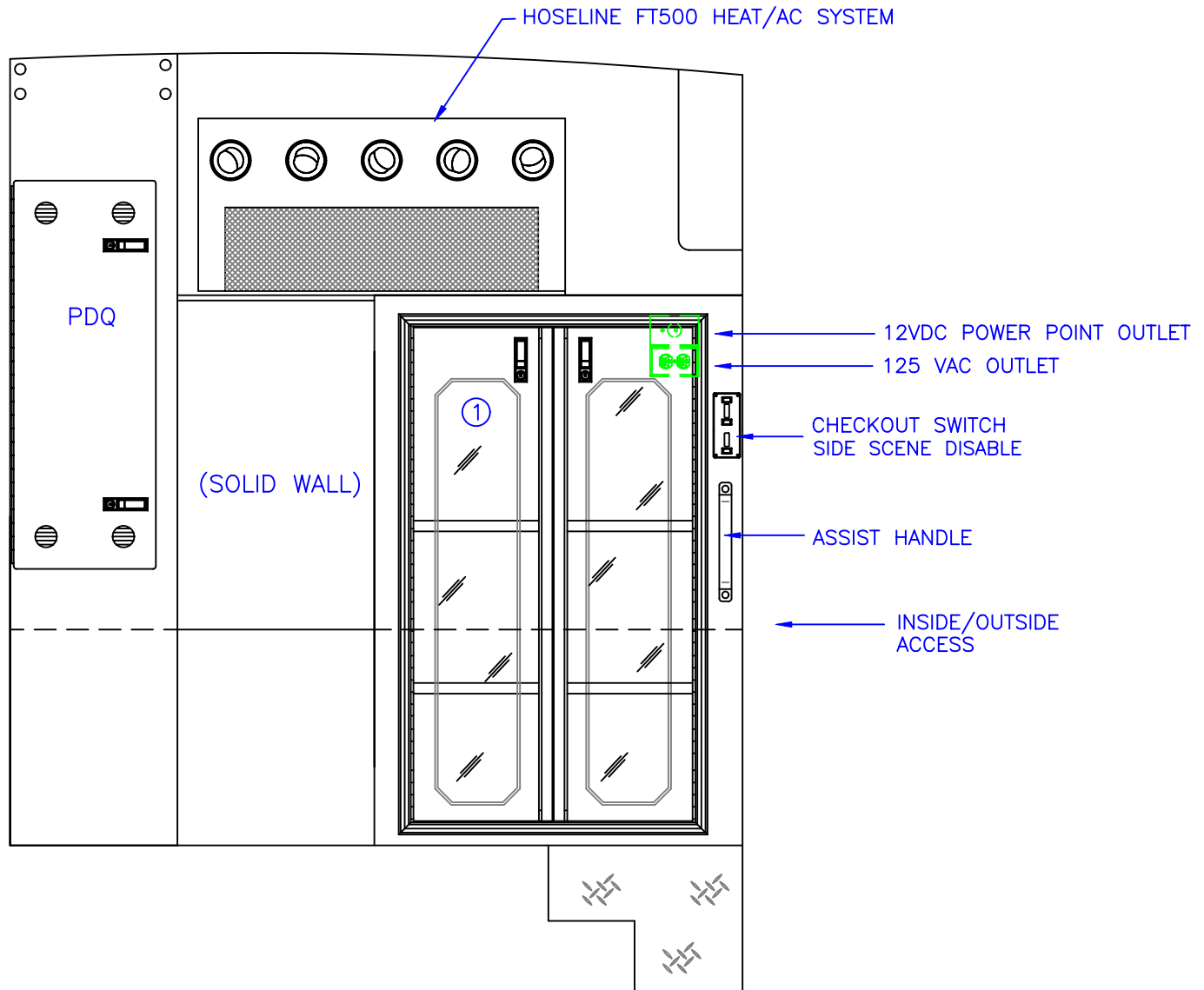

COMPARTMENT

- #1 DOOR OPENING: 46.00h x 26.25w
- INSIDE DIMS: 50.00h x 30.25w x 28.00d
- RECESSED .375" ACRYLIC DOORS WITH FULL LENGTH HANDLES
- TWO (2) LOCKING LEVER LATCHES
- TWO (2) ADJUSTABLE SHELVES

DIMENSIONS ARE NOMINAL



2010 PARTITION INTERIOR VIEW  
SUPER CHIEF METRO

DATE: 9 JAN 10		DRAWING NO.	
DWG. TKD	REV. NR	MSSC-7	
1:14			

BATTERY POWERED CLOCK

RECESSED 3-GLOVE BOX HOLDER

OXYGEN BYPASS

OXYGEN ACCESS

SQUAD BENCH NET

STAINLESS STEEL

STAINLESS STEEL

RED/WHITE REFLECTIVE STRIP  
ON INSIDE OF EACH DOOR

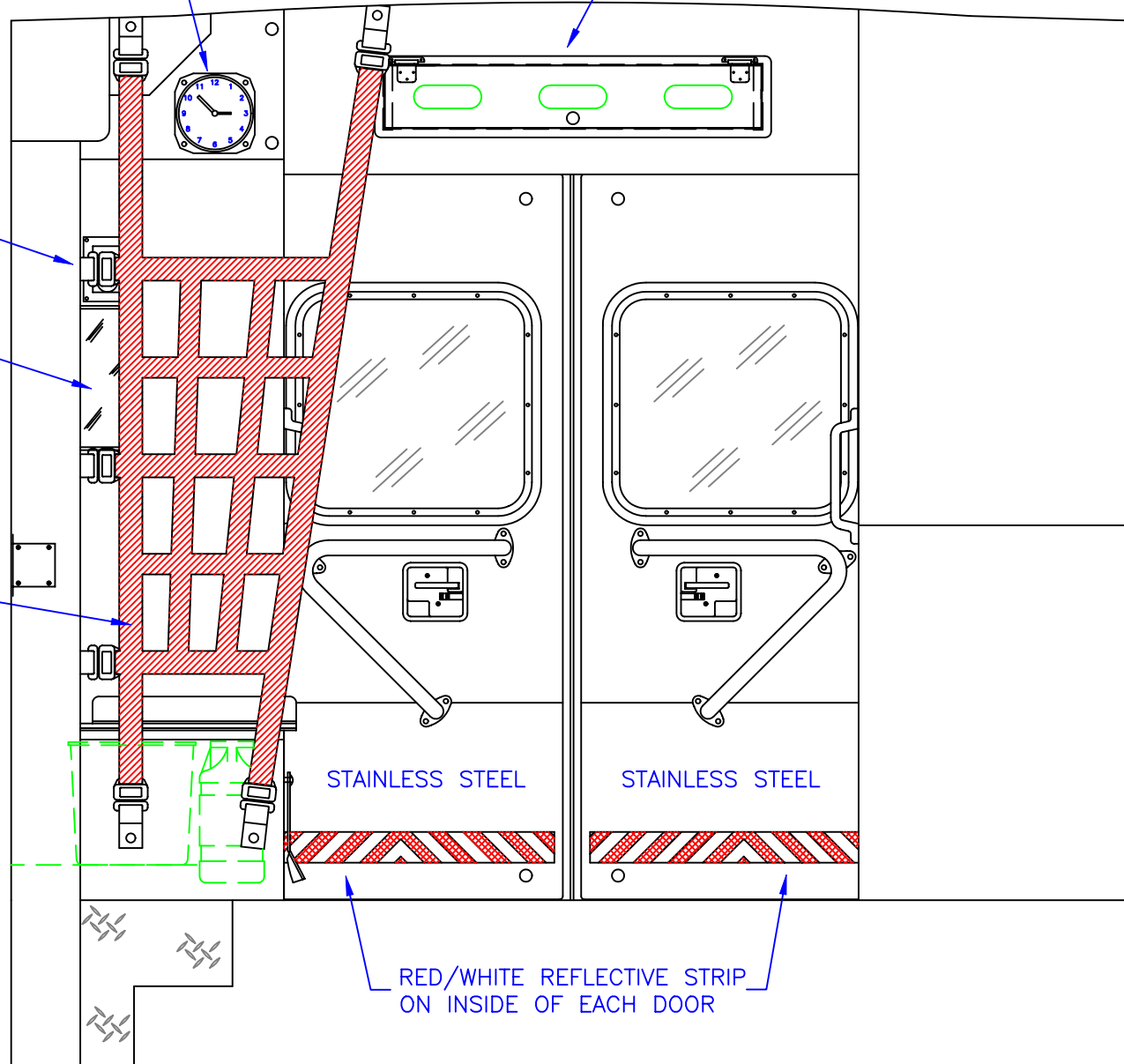

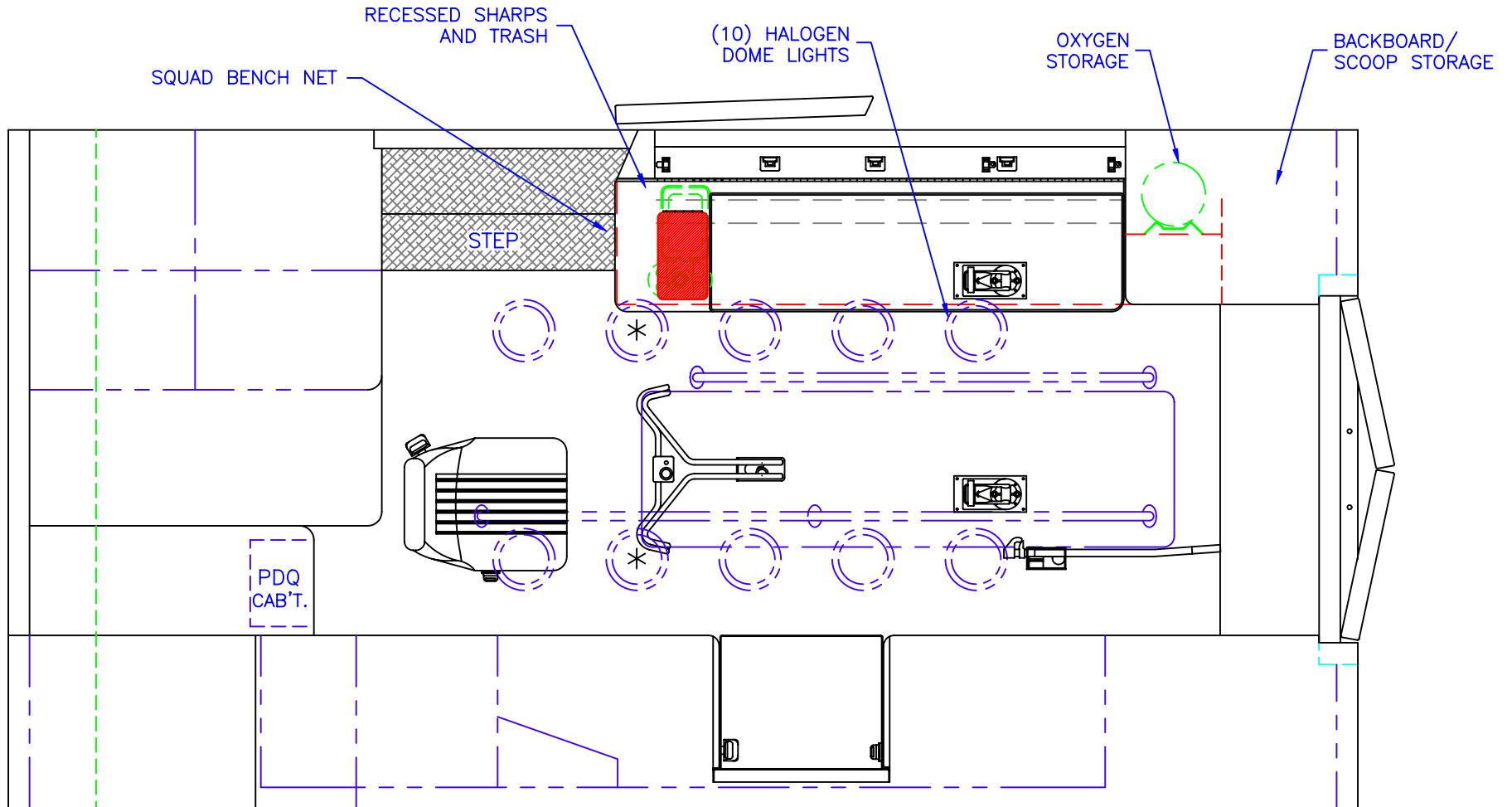

\* TWO (2) ANTENNA BASES LOCATED OUTBOARD OF DOME LIGHTS WITH COAX SERVICE LOOP

 TWO (2) RECESSED CEILING IV HANGER LOCATIONS

STRYKER CENTER MOUNT COT HARDWARE

MODULE WIDTH = 96"

MODULE LENGTH = 191"

MODULE HEAD ROOM = 73.5"

DIMENSIONS ARE NOMINAL